

Article number: 0101063
 Description: Retaining ring A 46 DIN 471
 Spring steel
 Note: Fitted with ZGA pilers

Measures

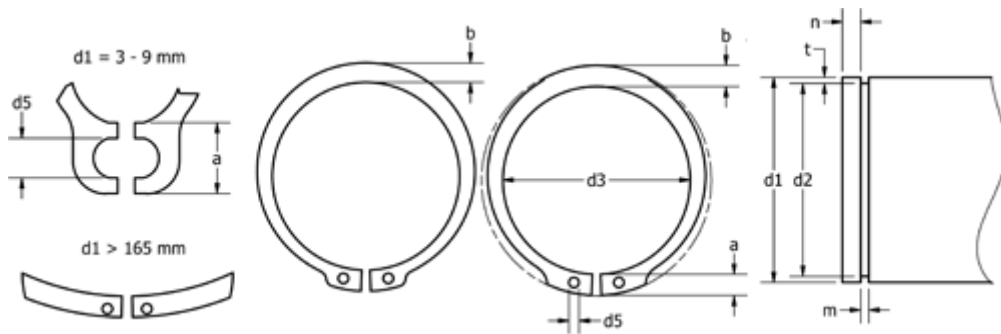

a max	= 6.7	FN kN	= 29.4	s	= 1.75
AN mm ²	= 177.0	FRg kN	= 9.40	t	= 1.25
b	= 4.8	FR kN	= 48.90	tol	= -0.25
d1	= 46	g	= 2.0	tol	= -0.06
d2	= 43.5	K kN-mm	= 90.20	tol	= +0,39-0,90
d3	= 42.5	m min	= 1.85	Tong	= ZGA-3
d5 min	= 2.5	n abl x 1000	= 11.0	Weight kg/1000	= 7.600
Description	= A46	Nominal drive	= 3.8		